



Robertshaw Industrial Products

Level Controls

Vibration Switches / Monitors

Controllers and Accessories

Control Valves

Self-Actuated Regulators

Control System Components

invensys®



Serving major control markets worldwide

Robertshaw is a major supplier to the industrial control markets worldwide. We have a broad product line of standard control devices to meet demanding customer requirements. Our product **versatility and in-depth experience** in this diverse market provide another example of our customer-driven, problem solving capability.

Robertshaw is a division of **Invensys, a global automation, controls and process solutions** group. As a global leader in resource productivity, Invensys offers products and services, expertise, and technologies that enable you to maximize return on investments, conserve resources and optimize performance across your value chain.

Our **application and service personnel** will assist you with any application or problem with new or existing equipment.

All of our products are supported with rapid response to customer needs including **Quick Shipment guarantees.**

Our entire operation is guided by Lean Manufacturing and Six Sigma quality processes, which assure the superiority of the products and services our customers receive from us. Robertshaw is an **ISO-9001-2000 registered** company.

New advanced control products for the future, like **Centeron® Wireless Tank Monitoring**, are being designed and produced at Robertshaw today. We have the products and service that deliver to the individual markets we serve.

Robertshaw designs and manufactures the following industrial control devices:

RF / Capacitance Microprocessor Level Controls, Monitors, and Probes
Vibration Switches and Monitors
Self-Actuated Temperature and Pressure Regulators
Diaphragm Control Valves
Pneumatic Control Systems Components

Call toll free **1-800-228-7429** to receive immediate assistance.

Or, visit our web site **www.robertshawindustrial.com**

Table of Contents



- **Level Controls**

- **Vibration Switches / Monitors**

- **Controllers and Accessories**

- **Control Valves**

- **Self-Actuated Regulators**

- **Control Systems Components**

Level Controls

Complete RF & Micro-processor Controls

Robertshaw level instrumentation uses the latest "state-of-the-art" solid state digital circuitry design for on/off and continuous level measurement in tanks, sumps, silos, and other vessels or containers. Products to be measured may include liquids, powders, granular, lump, and flake materials. No other equipment available from a single source can perform this variety of functions with so many different products.

Versatile Sensor Choices

Robertshaw sensing probes are the primary elements used with Robertshaw Level-Tek®, Level-Tel®, and microprocessor-based Level-Lance® instruments for level indication or control of granular or liquid materials, whether they are conductive, non-conductive, viscous, or low density powders.

Robertshaw probe design allows for easy installation. Entrance glands may have pipe threads or they can be supplied with standard ANSI B16.5 flange construction. The top end of the probe has an NPT fitting to accept the Robertshaw control instruments for direct mounting,

or a cable conduit outlet box or transmitter for remote mounted instruments.

• Model 740A / 741A Probes

The Model 740A / 741A is a general purpose rigid probe (Model 741A is a high gain) for level measuring applications involving liquids or dry materials. Available either bare (non-insulated) or Teflon insulated for use in conductive solutions.

Probes may be used in a wide variety of applications. Design categories include: rigid, flexible, concentric shielded, heavy-duty rigid, high temperature/pressure. There are a number of options - such as insulated Teflon rods for applications involving a conductive material or bare rods where the material is a good insulator. Other options: bent probes for applications where probe installation is not easily accomplished, sheath options to ignore build-up near the side of the vessel, Teflon facing on the process side of the flange where corrosive materials are used which will attack bare metal.

Rigid probes are available in lengths up to 20 feet, flexible probes are available up to 150 feet. Robertshaw can provide measurement or control of process level for almost any industrial application required.

Most models are CSA, UL or c-UL certified intrinsically safe when used as part of a certified I.S. system.

• Model 729A Probe

The Model 729A is a general purpose flexible probe for level measuring in applications involving liquids or dry materials where long lengths (up to 150 ft.) are required. Cable materials include 7/32" diameter stainless steel, 7/32" stainless steel with 3/8" OD Teflon or 7/32" stainless steel with 3/8" OD polyethylene insulation.



Other Typical Sensing Probes

- **Model 702A General Purpose Two-Piece Gland Probe**

Basically the same as 740A except it has a two-piece gland for applications requiring a bent probe. The two-piece gland permits locating the bent portion of the probe in the tank or vessel.



- **Model 727A High Pressure/Temperature Probe**

Same as 732A except the temperature/pressure rating is 1000 psig at 800°F.



- **Model 728B Heavy Duty Probe**

For rugged, heavy duty service where side-loading is a factor.

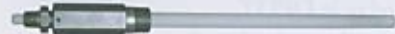

- **Model 732A Short-Stop Probe**

Eliminates errors usually introduced when product build-up occurs. This probe is used with short-stop versions of Model 318A solid state RF controller and the Model 5100 microprocessor-based Level-Lance® on/off controllers.



- **Model 736B Teflon Faced Flange Probe**

For corrosive environments. All wetted parts are Teflon.

- **Model 738A High Temperature/Pressure Ceramic Insulated Probe**

For very high pressure or temperature applications. Available in lengths up to 3 feet maximum. Rated 3000 psig at 300°F, 2000 psig at 500°F, and 1000 psig at 1000°F.



- **Model 739B Sanitary Flanged Probe**

For applications where ease of cleaning and/or removal is a requirement. Flange is a Tri-Clover fitting 16 Amp end cap welded and polished to meet 3A standards. Optional fittings (ferrule, gasket, and clamp) are available.



- **Model 150KB284/285 Non-Insulated Bare High Temperature/Pressure Probe**

For extremely high temperature/pressure applications. Flexible lengths available in lengths up to 100 ft., rigid lengths to 8 ft. Rated 5000 psig at 70°F, 4000 psig at 500°F, and 3000 psig at 1000°F. For use with non-conductive, low dielectric products only.



On/Off Solid State RF (radio frequency) Control Units

- **Model 304B Level-Tek® - CSA Certified**

Self-contained, on/off type control unit that mounts directly on a Robertshaw probe assembly. This unit provides contact actuation for external control action through a DPDT plug-in type relay. The Level-Tek features field-selectable high or low fail-safe modes, built-in LED for ease of calibration and adjustable differential and time delay features. Explosion-proof enclosure (also meets CSA enclosures 5 and NEMA 4, 12 requirements). All models provide an intrinsically safe probe input circuit (no safety barrier required).



• Model 310 Level-Tek® - CSA Certified

Model 310 is a remotely mounted on/off control unit that allows the electronics to be located away from the process. Electronics are connected to the sensing probe by means of a special triaxial cable. Unique circuit design eliminates the effects of temperature or cable capacitance to ensure measurement accuracy. Optional enclosures are explosion-proof (without lights) or CSA enclosure 5 (meets NEMA 4, 12 requirements) with red and green alarm lights. Model 310 uses a DPST relay for contact closures to external control, and provides field selectable high or low fail-safe modes, adjustable differential and time delay. Built-in LED for simple calibration. Most models provide an intrinsically safe probe input circuit (no safety barriers required).

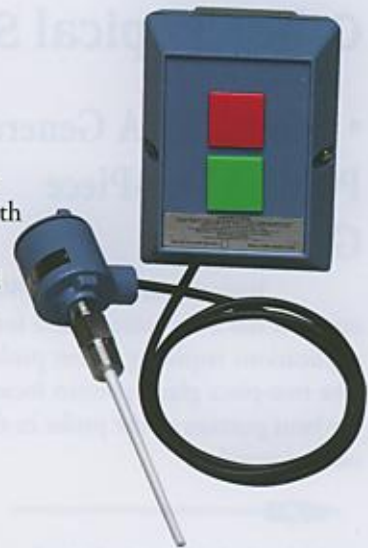

• Model 314B Duplex Level-Tek®

Model 314B is a self-contained on/off duplex control unit providing two independently adjustable set points, each with its own output control relay. Each set point has adjustable differential. The 314B mounts directly on a vertically-mounted Robertshaw probe assembly with the control point being adjustable throughout the length of the sensing probe. This Level-Tek is field changeable for a variety of fail-safe modes and has LED's (Light Emitting Diodes) to indicate relay operation as an aid in initial calibration. Enclosure is explosion-proof (also meets NEMA 4 requirements).



• Model 318A Level-Tek® CSA Certified (Non-short-stop version)

Special bridge type control instrument with optional "short-stop" circuitry. This option, when used with the "short-stop" probe, completely ignores product build-up on the probe surface. Model 318A has field selectable high and low level fail-safe and contains a unique adjustable time delay on relay pull in, drop out, or both. The enclosure is explosion-proof (also meets CSA enclosure 5 and NEMA 4, 12 requirements). The output relay is DPDT. Model 318A can be used with all standard probes. The 120 VAC non-short-stop model provides an intrinsically safe probe input circuit (no safety barriers required).



• Model 352 Conductivity Switch

For simple and economical on/off control of conductive liquids. Self-contained unit that mounts directly on the probe. Can detect conductive liquid level or interface between non-conductive and conductive liquids. Features include adjustable threshold resistance (200 ohms to 2 megaohms), plug in DPDT 5 Amp, 120/240 VAC relay, and field changeable fail-safe mode. Enclosure is explosion-proof (also meets NEMA 4 requirements).



Continuous Level RF Transmitters

• Remote Mounted Model 158A Level-Tel® - CSA Certified



Model 158A is a remote mounted sensing transmitter used for continuous level measurement or control. The Level-Tel® comes with or without local indication and provides a true current output signal for recording or control purposes. Optional enclosures are explosion proof, or CSA enclosure 5 (similar to NEMA 12 - also meets NEMA 4 requirements). A special triaxial cable is used to connect the electronics to the sensing probe. Unique circuit design completely eliminates any effect of temperature or cable capacitance to ensure measurement accuracy. All calibration adjustments are within the transmitter and are completely independent and non-interacting for both zero and span to ensure satisfactory operation on a variety of

measurement applications. Models are available which provide an intrinsically safe probe input circuit (require approved safety barrier).

• Vessel Mounted Model 167 Level-Tel® - CSA Certified

Self-contained sensing transmitter used for accurate level measurement independent of coatings or build-up on probe. Mounts directly on a Robertshaw sensing probe. Provides a true current output signal for indication, recording or control. Simple calibration with zero and span adjustments. Easy, minimum cost installation with 2-wire or 4-wire system. Built-in protection from lightning, reverse polarity, EMI. Explosion-proof housing (also meets NEMA 4 requirements). Two-wire version is intrinsically safe (requires approved safety barriers) and has CSA certified, intrinsically safe probe input circuit.

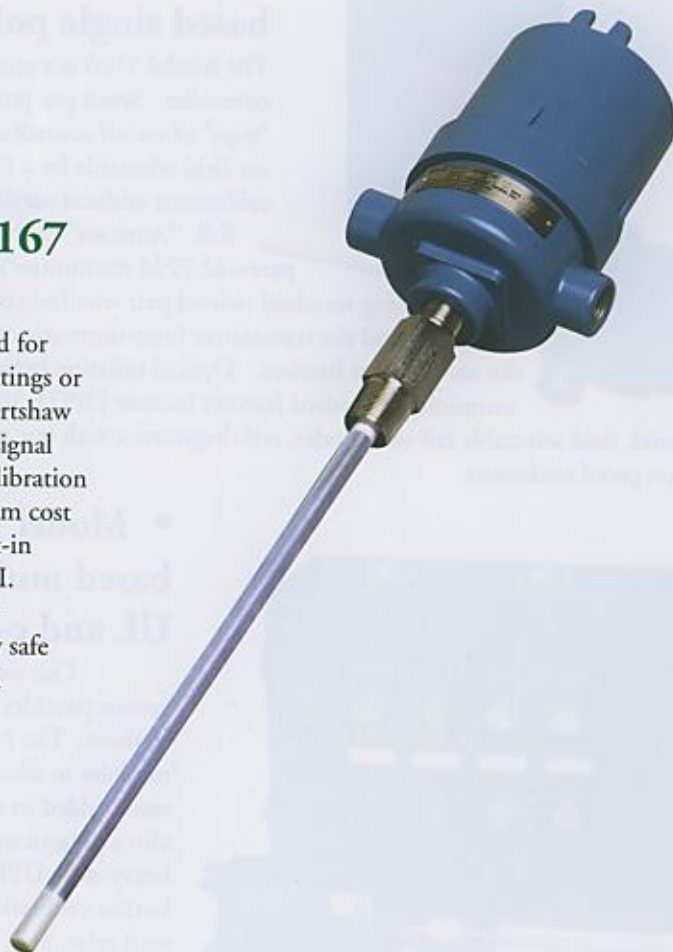

Microprocessor Based Controls

• A Patented Design

Robertshaw's patented PFM (Pulse Frequency Modulation) and microprocessor-based controllers solve many problems and inconveniences prevalent in previous generation instruments. The advantages of remotely locating the main electronic chassis and calibration controls away from heat and vibrations often encountered at the point of measurement are obvious.

All microprocessor Level-Lance® systems consist of our patented PFM transmitter and remote mounted level controller. The various controllers available provide either on/off, continuous, or multi-point control. The transmitter converts the probe signal to a variable period digital pulse output. The pulses, the duration of which are proportional to level, are transmitted via two ordinary wires (up to one mile transmission capability) to the microprocessor controller. The microprocessor manipulates the pulses by means of a program stored in ROM, in turn providing a 4-20 mA DC signal, relay actuation for alarm, or both, depending on the particular model. The transmitters contain no tuning or calibration adjustments. No primary power lines are required since the unit is powered by the same two wires which transmit the pulses to the controller. Normally the transmitter is mounted directly on the probe, but a remote mount type (15 feet maximum) is available if temperature or vibration is excessive. The remote type is connected to the probe via coaxial or triaxial cable (if short-stop model). The PFM transmitter is mounted in an explosion-proof enclosure. Power levels are designed to meet intrinsic safety requirements.

Entry of set point data is by means of a simple toggle switch, pushbutton, or keypad (depending on the model), thereby eliminating the need for tools and providing consistent results regardless of operator skill.

Several different programs are stored and manually selected, making one simple instrument a truly versatile and economical controller. The various features for each particular instrument are show below and are such that almost every type of application can be handled by one or the other.

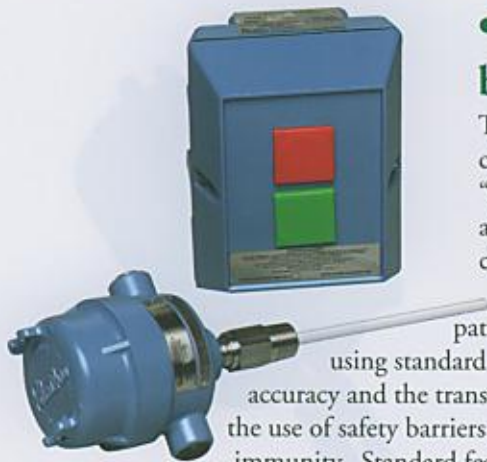

• Model 5100 Level-Lance® Microprocessor - based single point on/off level controller

The Model 5100 is a microprocessor-based advanced technology on/off level controller. Seven pre-programmed control modes allow the user to select the "type" of on/off control action best suited for his application. Control modes are field selectable by a 10-position rotary switch. Four of these modes permit calibration without varying the process level and/or with the vessel empty or full. "Auto-set" calibration eliminates screwdriver or knob adjustments. The patented PFM transmitter allows one mile transmission to the remote receiver using standard twisted pair wire (no coax or triax). Digital transmission assures no-loss accuracy and the transmitter (non-short-stop version) is UL and c-UL certified intrinsically safe with the use of safety barriers. Optical isolation between transmitter and receiver provides enhanced noise immunity. Standard features include DPDT 10AMP relay, digitally set time delays, adjustable differential, field selectable fail-safe modes, self-diagnostics with test mode. Optional features include indicating lights and explosion proof enclosures.

• Model 5400A Level-Lance® Microprocessor-based multi-point on/off level controller UL and c-UL Certified

Our newest microprocessor-based multi-point on/off level control system provides economical 1-4 point control using only one sensing element. The Model 5400A is designed with plug-in type relay output modules to allow for easy configuration changes. Relay outputs can be easily added in the field by the user. The control unit PFM input circuit is also a plug-in module for easier field servicing. Standard features include heavy-duty DPDT 10 Amp relays, non-volatile memory, "Auto-Set" push-button calibration, independent time delay and adjustable differential for each relay, high or low fail-safe selection, lead-lag program for automatic



- **Model 5400A Level-Lance® Microprocessor-based multi-point on/off level controller (cont'd)**

pump alteration, self-diagnostics with LED failure indication (indicates transmitter, sensor, or digital circuitry failure), EMI/RFI rejection, optical isolation between PFM transmitter and controller, electro-static protection at the probe input, and a test program to verify functional operation. The PFM transmitter is mounted in a weather-proof enclosure and is UL and c-UL certified intrinsically safe without a safety barrier. The PFM transmitter does not require any calibration or primary power and can be mounted up to one mile from the control unit using two ordinary wires - no coaxial or triaxial cable is required. Optional features include: 1-4 relay output modules; red/green alarm indicating lights on instrument door; NEMA 4, NEMA 4X (stainless steel), NEMA 4X (non-metallic), or explosion-proof enclosures; and 18-30 VDC or 120/240 VAC switch-selectable supply power. This exceptionally versatile on/off controller provides economical 1-4 point level control with a host of added features and options to fit almost any application.

- **Excalibur 7000 Level Control**

Robertshaw's Excalibur 7000 offers two controls for the price of one. Both a smart Level transmitter and PID Controller, this unique instrument provides the flexibility to meet all your level application requirements. The Excalibur 7000 has built-in PID Control with auto tune to eliminate offset and provide accuracy and stability. The auto tune feature eliminates periodic on-line tuning by automatically matching control action with your particular process characteristics. Optional anti-coating circuitry eliminates errors due to product build-up on the probe. Robertshaw's patented PFM transmitter technology provides digital transmission up to one mile using economical twisted pair wire (no coaxial cable required). Built-in field selectable input linearization allow open channel flow measurement and level control with volume conversion for non-cylindrical or horizontal cylindrical vessels. Simple menu prompts guide you step-by-step through setup and calibration. Entry can be by built-in keypad, HART Calibrator or PC. Calibration can be accomplished without completely emptying or filling the vessel. Two or four SPDT 10 AMP alarm relays with differential and time delay are optional. All have field selectable high or low level fail-safe.

Continuous self-diagnostics and test/verify pushbutton ensure you of constant reliability and safety. The transmitter (non-anti-coating version) and sensing probe are UL and c-UL certified intrinsically safe with the use of safety barriers. Explosion proof enclosures are optional. Analog/Communication options include isolated 4-20 mA DC/HART Protocol, Modbus RS-485 or RS-232. And, the Excalibur is fieldbus upgradeable.



• Model 5000A Microprocessor Level-Lance® for Continuous Level Control

Model 5000A is an outstanding digital electronic system for continuous level indication and control. This "patented" microprocessor controller receives and processes variable period pulse signals from the PFM transmitter and translates the pulse width into a digital readout. Contains programs for readouts on a 0 to 100% scale or any engineering unit scale. Units are displayed on an easily read Liquid Crystal Display (LCD). A special program is included which allows calibration without completely emptying or filling the vessel. Two independent DPDT 10 AMP relays with adjustable differential and time delay are included for control. An optional circuit card can be added for 4-20 mA DC isolated output. Other features include field reversible output, self-diagnostics, "Auto-Set" switch calibration, and optional "smart chip" for non-linear characterization for volume or flow measurement in horizontal cylindrical tanks, weirs, flumes, etc. Power supply options include 18 to 30 VDC, 120 or 240 VAC. AC voltages are switch selectable. Enclosure options include NEMA 4 with window, explosion-proof without window, or explosion-proof with window. The transmitter and sensing probe are UL and c-UL certified intrinsically safe with the use of safety barriers.



Continuous Level Control

• Principle of Operation

The basic principle of operation for continuous level measurement is the same as for on / off controllers (see page 8), except the output is proportional rather than relay actuation. However, some models have both. The EXCALIBUR 7000 is an outstanding achievement in patented digital technology. This unit gives you two controls for the price of one; a SMART Level Transmitter and complete PID Process Controller – with auto tune. This versatile instrument provides the flexibility to meet all your level application requirements – save you time, money, and reduce your parts inventory. The EXCALIBUR 7000 does it all, plus it's HART compatible and FIELDBUS upgradeable.

A variety of sensing probes are available to suit your applications; high temperature / pressure, sanitary, flanged, inactive lengths, grounded for non-metal tanks, rigid, flexible, bare or insulated.

• Typical Applications

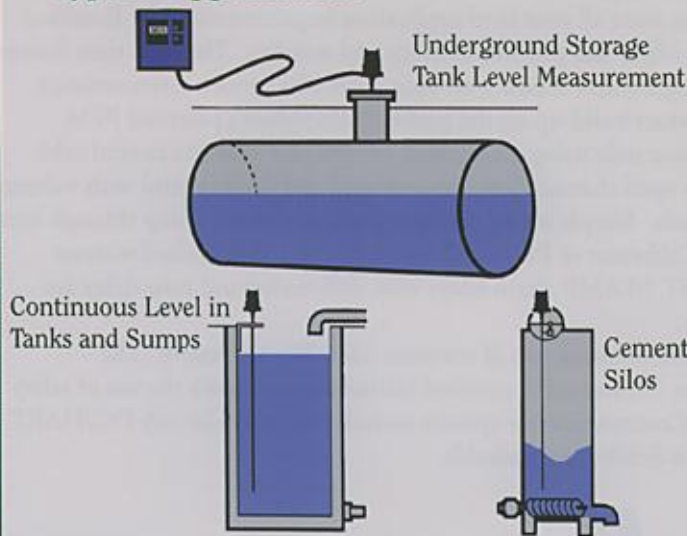

• Tank Volume/Level Indication

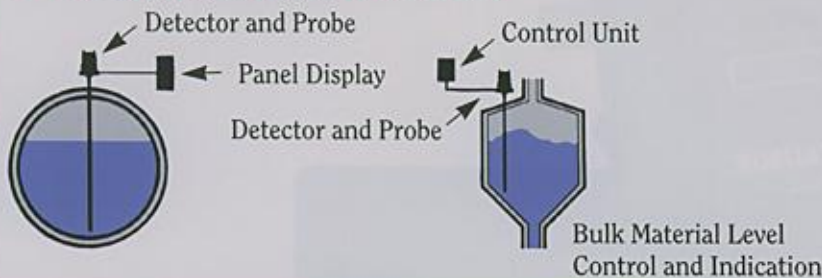

• Open Channel Flow

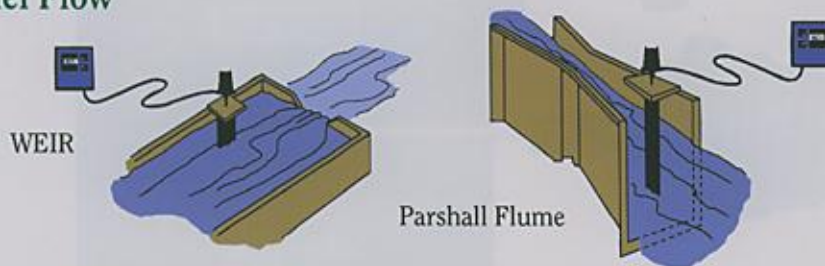

On / Off Control

• Principle of Operation

An electrode (sensing probe) installed in a vessel becomes a variable capacitor, the electrode being one side / plate and the tank wall (and the material itself, if conductive) the other, or ground, side / plate of the capacitor.

Robertshaw RF and microprocessor-based controls utilize the basic principle that a capacitor will change its electrical value directly proportional to dielectric value and / or plate area change, and inversely proportional to the distance between the plates. Therefore, the capacitance value will increase or decrease as the product being measured rises or falls within the vessel, thus providing a simple and maintenance-free (no moving parts) method of level measurement.

Three different measurement techniques are used, each a state-of-the-art concept having a special place in the broad applications spectrum. Special consideration is given to build-up of conductive materials on the surface of the probe. Robertshaw's short-stop circuitry and probes completely eliminate false trips due to build-up and are offered as options.

Accurate measurements can be made of dry products – ranging from light powders to heavy, dense materials – and liquids ranging from light hydrocarbons to highly conductive materials, such as water, acids, etc. Measurements can be made with immersed type probes or non-contacting proximity types. Numerous sensing probe types are available, so tailoring to meet your exact needs is a simple procedure.

Outputs on the Level-Tek® and on / off Level-Lance® microprocessor-based instruments are relays. Models including one, two, three, or four relays are available and include adjustable differential (deadband) for cyclic control action, adjustable time delay to prevent sporadic relay actuation due to turbulent level (wave action), and lead-lag pump control modes.

• Typical Applications

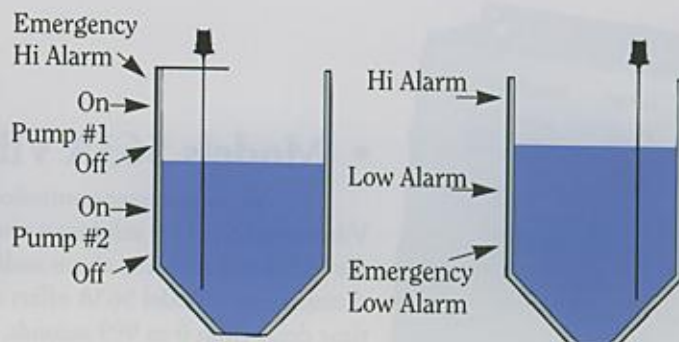
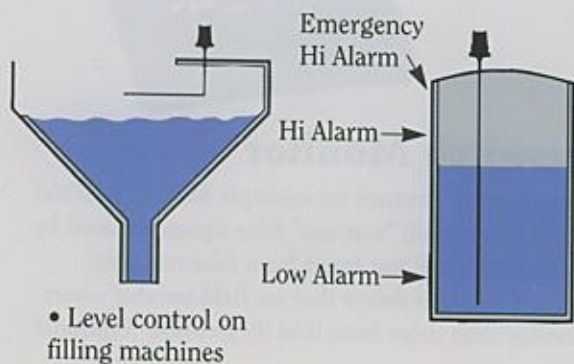
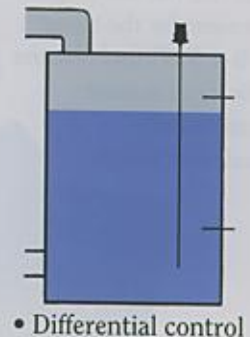
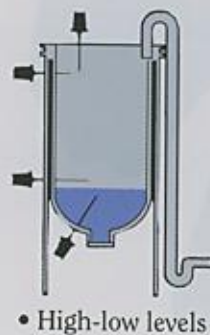
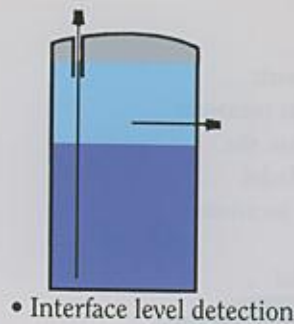
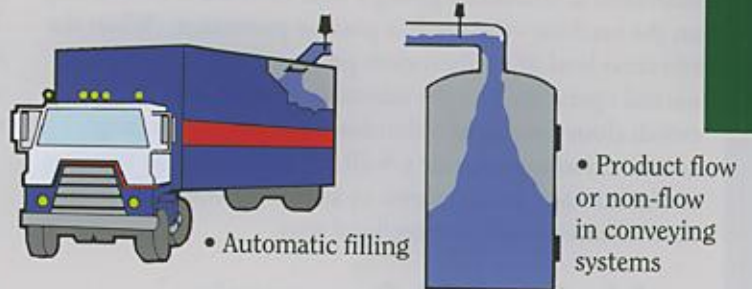
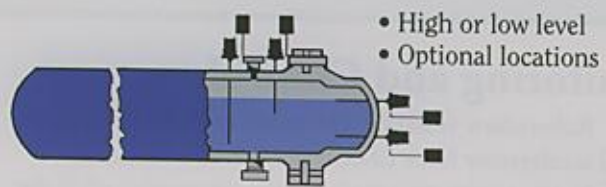

Vibration

Monitoring and Control

Robertshaw vibration switches and monitors measure the total acceleratory force (shock) present on a machine. Acceleration measurements made are the summation of all the individual accelerations giving a total destructive force acting on the machine - the result is positive protection. When the vibration level of a Vibraswitch protected machine exceeds normal operation by a pre-selectable amount, an internal switch closes, actuating a shutdown before costly damage occurs. Monitors provide a 4-20 mA DC signal for trending and/or contacts for shutdown or alarm. Versions also provide start/monitor delays, remote/local reset.

• Models 368 Pneumatic Vibraswitch

The Model 368 is a pneumatic acceleration sensitive instrument that measures the total acceleratory shock present on the machine. Being non-electric, the Model 368 may be employed in hazardous locations without the usual necessity of an explosion-proof housing. The Model 368 does not require any form of external power to operate. The device has one setpoint adjustment for the range from 0-4.5 G's and features the choice of remote pneumatic or manual reset at unit.



• Models 365/366 Vibraswitches

Models 365/366 Vibraswitches are acceleration sensitive instruments that measure the total acceleratory shock present on the machine. The Model 365 is designed for hazardous areas and is housed in an explosion-proof enclosure. The Model 366 is housed in a weathertight enclosure for non-hazardous areas. The Vibraswitches feature a manual reset and coil for remote electrical reset. Easily calibrated by means of one setpoint adjustment for a range of 0-4.5 G's. An optional internal space heater is available to prevent moisture inside the housing.



• Models 375A/376A Vibraswitches

Models 375A/376A are identical to Models 365/366 except that they incorporate built-in electronic starting, monitoring, or combination starting and monitoring time delay circuits. The integral time delay circuits will not take alarm or shutdown action on false transient disturbances received by the Vibraswitch.



• Models 563A Vibraswitch Monitor

Microprocessor-controlled "supervisory" control for multiple Models 365/366 Vibraswitches. This solid state electronic system will "sort out" false signals received by the Vibraswitch so that alarm and/or shutdown will not result from false transient disturbances. Model 563A offers start and monitor delays that are field settable - start time delay from 0 to 999 seconds, monitor time delay from 0 to 99 seconds. Optional NEMA 4 or explosion-proof enclosures.

• Model 566 Velocity-Acceleration Vibration Monitor - FM Approved - CSA Certified

Robertshaw's newest Model 566 vibration monitor is an all solid state instrument that encompasses a variety of functions in one unit. Vibration can be monitored in either velocity or acceleration. The standard ranges are 0 to 1.5 inches/second or 0 to 3 inches/second when sensing velocity, and 0 to 5 G's or 0 to 10 G's when sensing acceleration. A 4-20 mA DC output is standard.

The Model 566 includes two solid state Triacs (2 Amp at 120/240 VAC) which can be operated in a N.O. or N.C. configuration. Alarms are capable of being latched or non-latched. A time delay function is also a standard feature and is adjustable from 0.5 to 15 seconds. LED setpoint indicators are provided to indicate the alarm condition. Options include P/S (120 or 240 VAC) and remote sensor. The remote sensor can be located up to 1,000 feet away using only a standard ungrounded pair of twisted wires.

The Model 566 enclosure is weatherproof and explosion-proof. It is CSA certified and FM approved for Class I, Division I, Groups C and D; Class II, Division I, Groups E, F, and G hazardous locations. Housing for the remote mounted transducer has the same ratings and is also FM approved for Class I, Division I, Group B.

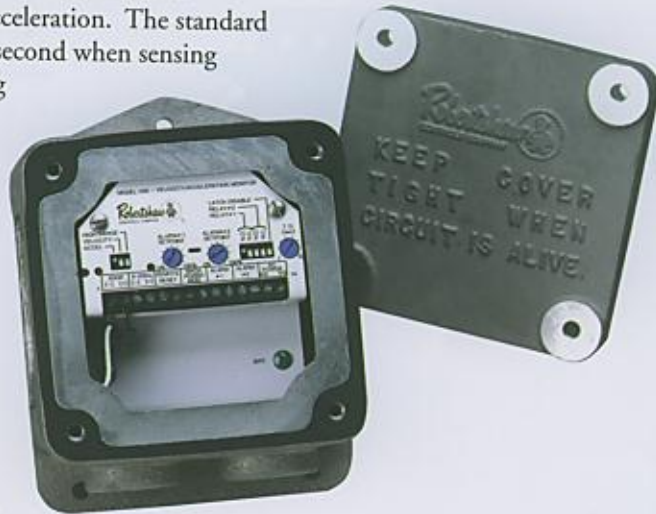

• Model 570B and 571A Loop Powered Stud Mount Vibration Transmitters

Model 570B is a loop powered (10-30 Vdc) transmitter which provides a 4-20 mA DC output proportionate to vibration. It is available in 6 ranges, 0-5 G, 0-10 G or 0-20 G acceleration or 0-0.5 IPS, 0-1 IPS or 0-2 IPS velocity. The frequency range is 2Hz to 2KHz. This rugged compact unit provides continuous monitoring of machine vibration for trending, alarm and/or shutdown when used with a PLC, computer, DCS, data logger or current relays. The enclosure is 316L Stainless Steel, NEMA 4X (hermetically sealed), and meets IP68. Installation is simple and no calibration is required. An integral 1/4-28 stud is provided for mounting. The unit has a 2 pin connector and mates with a standard MIL-C-5015 2 socket connector with a splash proof connection. Optional cable assemblies are available in lengths of 16, 34, 64, and 112 feet. Model 571A is an intrinsically safe (14-30 Vdc) version of the model 570B. The model 571A is CSA Certified for the US and Canada and is ATEX Certified for Europe. A safety barrier is required.



- **Typical Vibraswitch Installations**

The following line drawings show the recommended locations for mounting the Vibraswitch on various machines.

- **Engine – Gear Centrifugal Compressor**

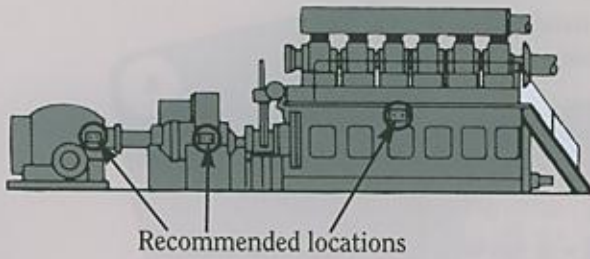

- **Cooling Tower Fan**

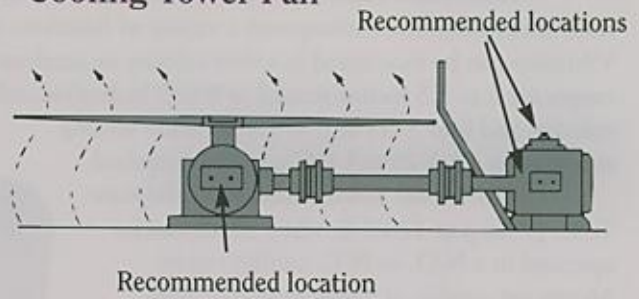

- **Reciprocating Compressor "Y" Type**

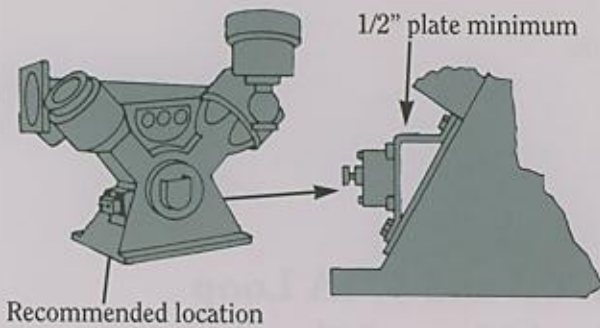

- **Horizontal Opposed Reciprocating Compressor**

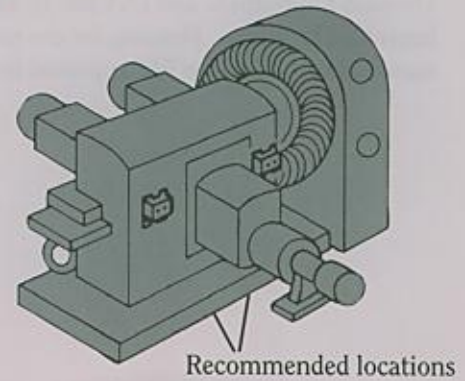

- **Diesel Engine Compressor Unit**

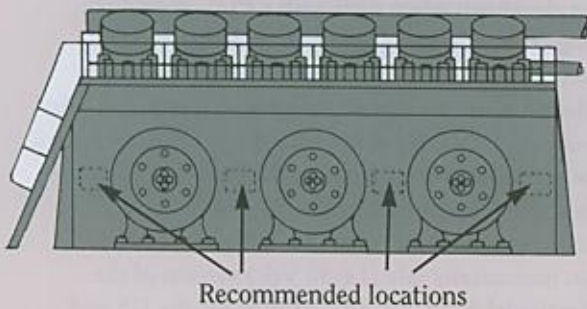

- **Centrifugal Pump**

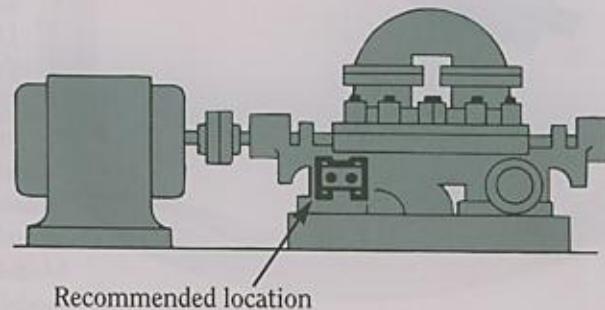

Controllers and Accessories

Model DT-700 Temperature Controller

Model DT-700 Fultrol pilot controller uses rod and tube differential expansion principle to control pilot valve position and resultant signal pressure is applied to final control actuator. It may be used for heating or for cooling applications. Control action may be direct or reverse, facilitating choice of final control valves to seek either full-open or full-closed position upon loss of supply pressure.

Ranges: Any 200°F span between -50°F and 350°F

Output Signal: 3 to 15 psig standard; 6 to 30 psig available

Supply: Air, gas, low-viscosity oil

Throttling Band Adjustment: 5°F to 25°F (2 1/2 psig/°F to 1/2 psig/°F)

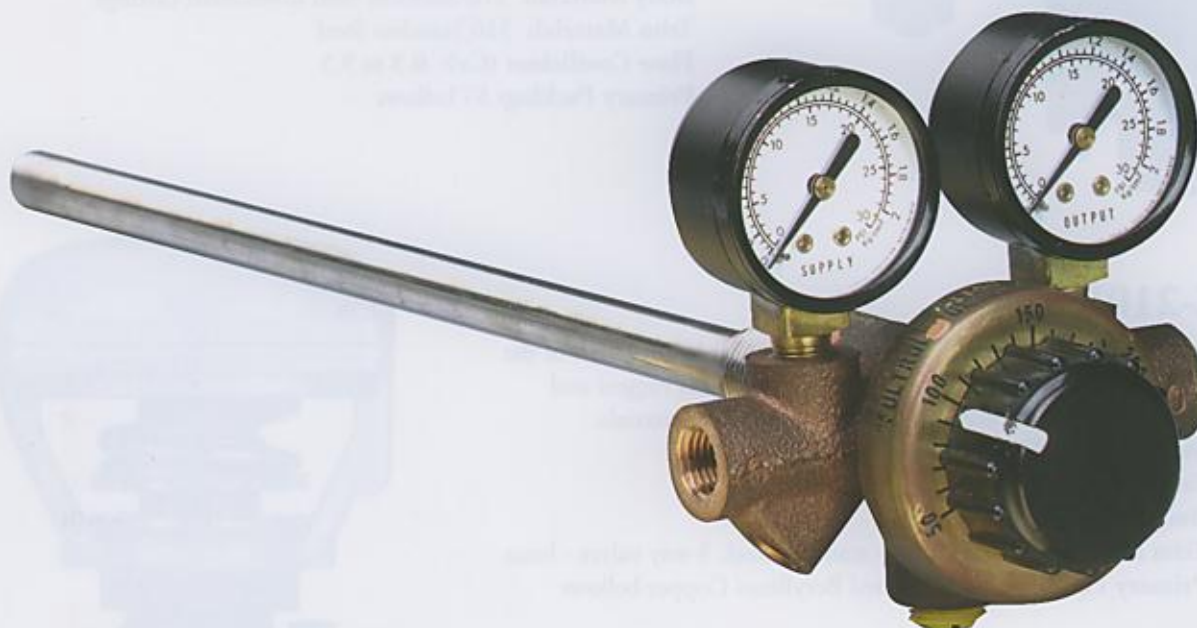

- **Models 443A/445A
Current to Pneumatic
Converters**

Models 443A/445A electro-pneumatic relays convert a DC signal to a proportional pneumatic signal. They broaden the scope of pneumatic instrumentation by utilizing the speed of electrical transmission, reducing time-distance factors. Compact design with direct or reverse action, excellent frequency response and dampening. Explosion-proof housing for Class I, Groups C and D, Div. 1 hazardous locations. High accuracy with $\pm 0.50\%$ (standard), $\pm 0.25\%$ (optional). FM/CSA certified.

Control Valves

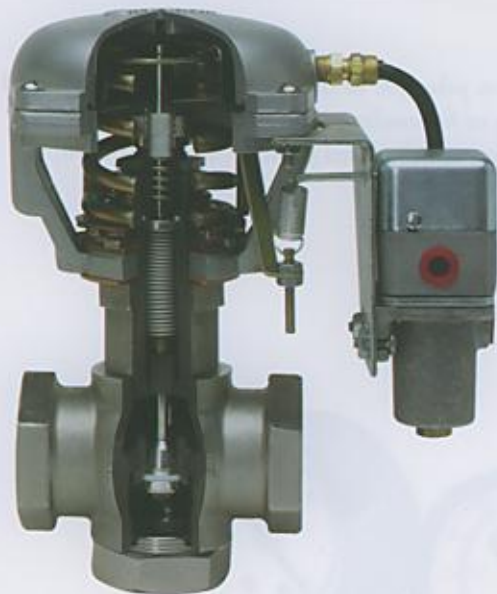

- **'Mini-Max' VC-210 Valve**

Model VC-210 diaphragm actuated control valves are compact, ruggedly constructed and designed for control of water, gas, steam, or vacuum. Single-seated valves are bellows sealed to prevent stem leakage. Valves may be two-way, fail-open or fail closed, or three way, operated by a 10 sq. in. BUNA-N 2 ply dacron reinforced diaphragm in a die-cast aluminum housing and frame assembly.

Valve sizes: 1/2", 3/4" and 1"

Ends: screwed

Body Material: 316 Stainless Steel investment castings

Trim Material: 316 Stainless Steel

Flow Coefficient (Cv): 0.3 to 9.5

Primary Packing: SS bellows

- **VC-210B Valve**

Model VC-210B is the **ECONOMICAL** (BRASS) version of the VC-210 Series. Similar in design to the "Mini-Max", it is rugged and compact. The major difference is the body and bellows materials.

Valve sizes: 1/2", 3/4", and 1"

Ends: Screwed

Body Material: Brass

Trim Material: 2-way valves - stainless steel, 3-way valves - brass

Primary Packing: Nickel plated Beryllium Copper bellows



- **Model P2 Side-Mounted Valve Positioner**

Converts 3-15 psig control air signal to proportional output air signal. 30 psig maximum output pressure increases control sensitivity and provides greater close-off pressure. Also used for split-range applications.

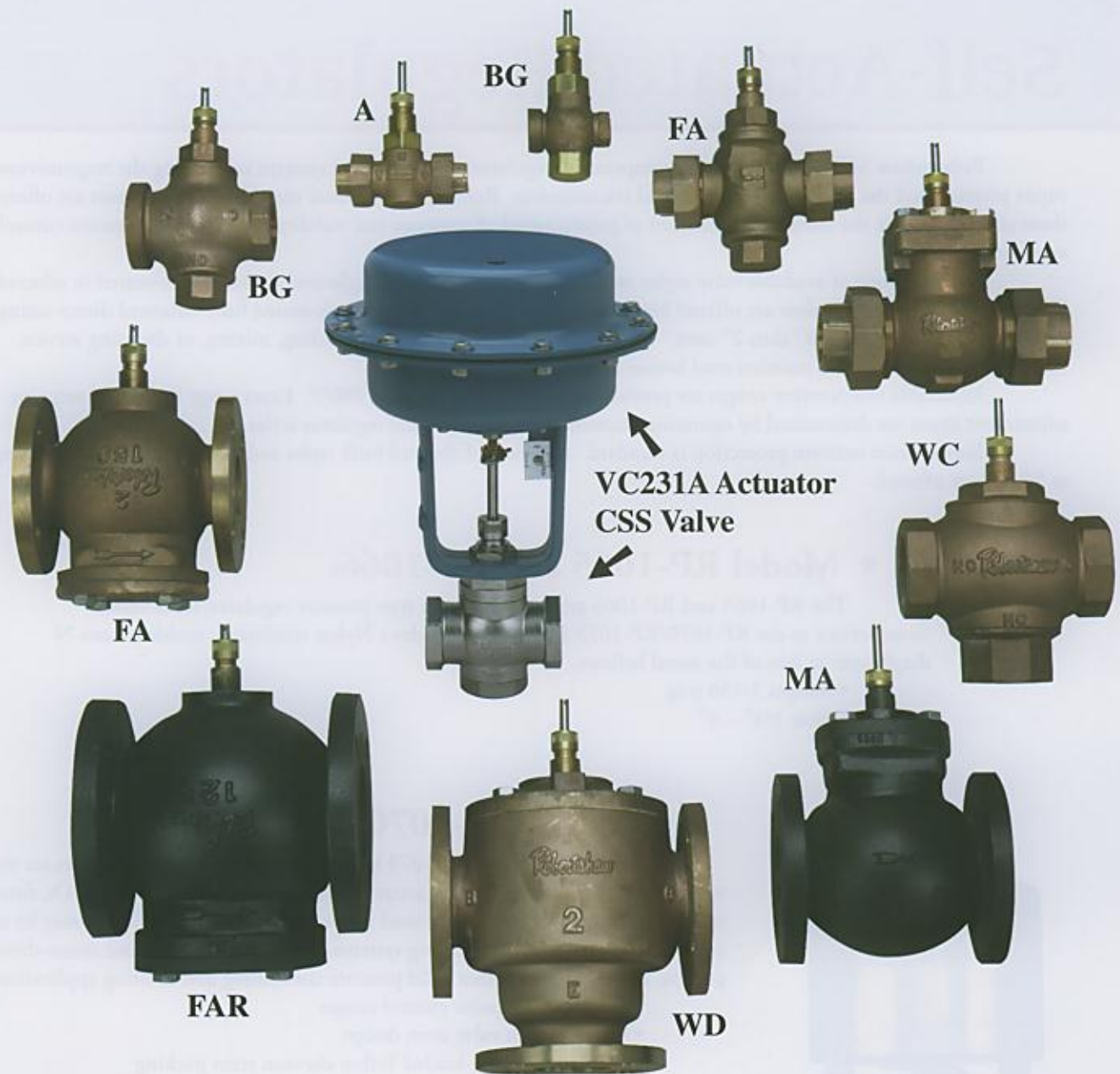

• Models VC-230A / VC-231A

Models VC-230A and VC-231A diaphragm actuated control valves feature a 30 sq. in. multi-spring actuator with a molded BUNA-N diaphragm in a steel casing. Lower frame is cast iron. Springs are wound from high quality alloy steel. A wide choice of valves includes single seated and double seated two way valves in sizes 1/2" to 4". Three-way valves are single plug between two seats (1/2" to 6"). Flanged, screwed, and union ends connections available.

Actuator Action:

VC-230A — Air to push down

VC-231A — Air to push up

Maximum Travel: 1 1/32"

Spring Range: 3-15 psig (20 to 107 kPa) standard.

Other ranges available.

Valve Specifications: Varied — contact factory.

Self-Actuated Regulators

Robertshaw SATR's (self-actuated temperature regulators) have thermal systems combining the responsiveness of vapor pressure and the positive action of liquid transmission. Robertshaw seamless metal bellows actuators are offered in three sizes to provide the correct combination of power, speed of response and stability for many temperature control applications.

The full range of available valve styles includes sizes 1/4" thru 6", single-seated and double-seated in selected sizes. Direct and reverse-acting valves are offered for heating or cooling service. A single-seated fully-balanced direct-acting valve, style MA, is standard for 3/4" thru 2" sizes. Three-way valves are offered for blending, mixing, or diverting service. Robertshaw has now added stainless steel bodies in 1/2" thru 2".

Adjustable temperature ranges are provided from 10°F to as high as 480°F. Exact range limits and setpoint adjustment spans are determined by operating characteristics of individual regulator styles.

Temperature overrun protection is standard. A variety of thermal bulb styles and armored capillary tube lengths up to 50 feet are offered.

- **Model RP-1065 and RP-1066:**

The RP-1065 and RP-1066 are the diaphragm type pressure regulator/relief valves. Same service as the RP-1070/RP-1073 Series, but includes a Nylon reinforced, molded Buna-N diaphragm in lieu of the metal bellows.

- Ranges 3-150 psig
- Sizes 1/4" - 4"

- **Model RP-1070 and RP-1073:**

The RP-1070 and RP-1073 bellows actuated pressure regulators are simple, self-operated and offer sensitive, accurate control of reduced pressures. Or, fitted with a reversed-acting valve they can be used for pressure relief service. They may be used to control steam pressures for heating systems, industrial processes and steam-driven pumps, as well as many other fluid pressure controlling and limiting applications.

- Choice of set point control ranges
- Quick detach valve stem design
- "Lifetime" spring-loaded Teflon chevron stem packing
- Ranges 3-55 psig

- **Model RP-1072 Series:**

The RP-1072 Series regulators are restricted to vacuum applications. The range of pressures under control cannot vary beyond 0 psig and -14.7 psig.

- All metal construction
- Large 2-ply seamless bellows
- Sizes 1/4" - 4"



Self-Actuated Regulators

- **Model RT-1001-B1**

Two-way single-seated and double-seated valves, direct and reverse-acting. Three-way valves for mixing or diverting. Sizes 1/4" to 4". Wide throttling band for maximum stability. Approximately 60°F spans from 15°F to 480°F.



- **Model RT-1001-P thru S "Quick Ship"**

Fixed specification of the RT-1001-B1 SATR sizes 1/2" to 2" for heating or cooling, built to order.

- **Model RT-1001-T2 Heater/Treater SATR**

Specific model of RT-1001-B1 designed to meet requirements of the Heater/Treater market. Combines rugged durability of our SATR's with small bulb and tight-shutoff stainless steel valve assembly to provide longer life and higher performance under demanding conditions of the oil and gas fields.

- **Model RT-1003 / RT-1009 Series**

Same valve selection as RT-1001-B1. Medium throttling band. More power and sensitivity than RT-1001-B1. Approximately 60°F spans between 10°F and 455°F. Available with thermometer integral with thermal system for indication. RT-1009 has override for manually positioning valve.

- **Model RT-1004 Series**

Same valve selection as RT-1001-B1. Extra large actuating bellows for narrow throttling band, maximum power and sensitivity. Larger thermal bulbs. Approximately 45°F spans between 35°F and 425°F.

- **Model RT-921 Series**

Small overall size. Sizes 1/4" through 1" with or without temperature indication. Excellent for OEM applications.

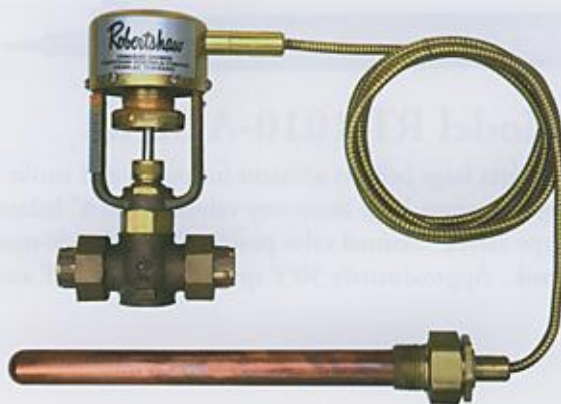

• **Model RT-1006-B1 / RT-1007-A1**

Not Pictured. Fail-safe design. Should damage to thermal system cause loss of thermal charge, direct-acting valve (heating service) closes and reverse-acting valve (cooling service) opens to prevent overheating. Valve sizes 1/4" to 1" on RT-1006-B1; 1 1/4" to 4" for RT-1007-A1 with extra large bellows actuator. Approximately 30°F spans between -50°F and 325°F.

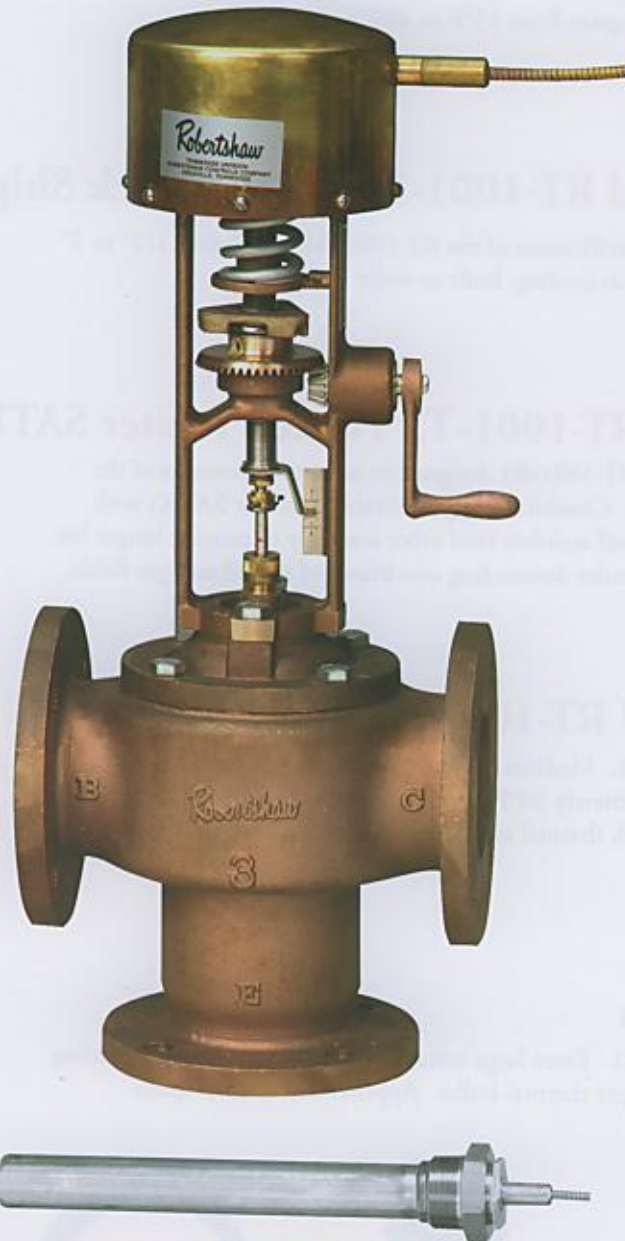
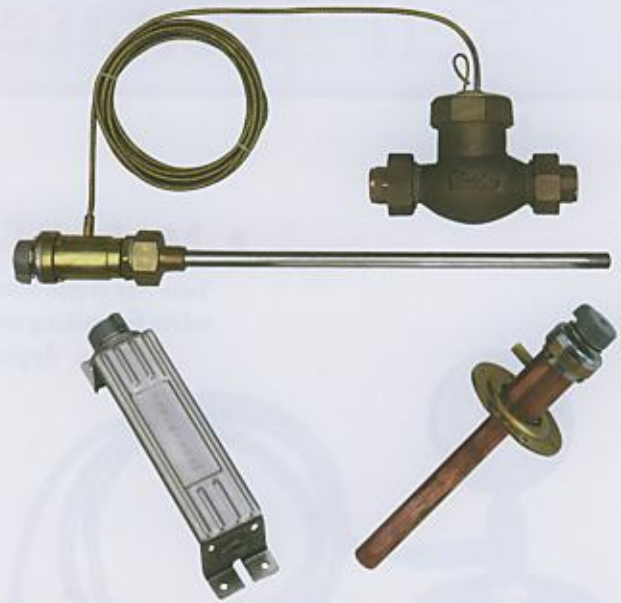

▲ **Model RT-200 Compact Hot Chamber Temperature Regulators**

The RT-200 Series compact self-actuated temperature regulators are designed for steam heating service, 15 psig or 75 psig maximum.

Units are available with remote sensing bulbs designed for wall or duct mounting or liquid immersion. The small valves are packless bellows sealed. Setpoint adjustment is possible over 60°F maximum spans between 35°F and 170°F.

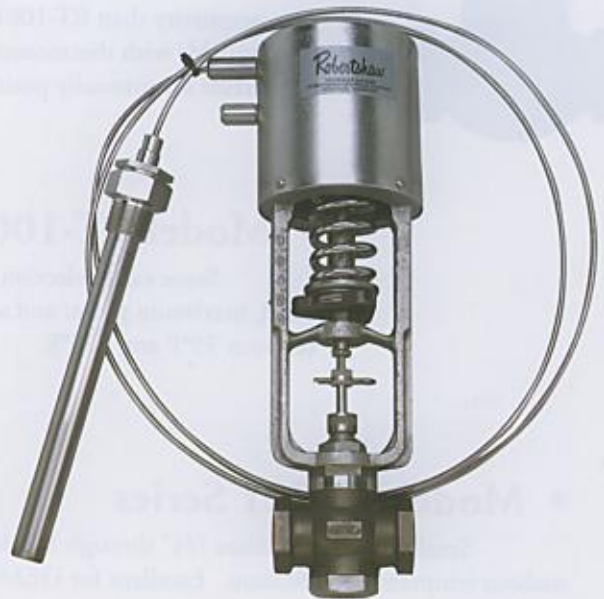

▲ **Model RT-1011-B1 Series**

From the bulb head through the regulator frame, all parts exposed to the atmosphere are made of 18-8 stainless steel. Specifications similar to RT-1003 Series.

▲ **Model RT-1010-A Series**

Extra large bellows actuator for power and stroke necessary to operate large three-way valves. 3" to 6" balanced sleeve-type valves. Manual valve positioning with side-mounted hand crank. Approximately 30°F spans between -35°F and 415°F.

Instantrol® Steam/Fluid Heater Package

Instant hot water or other fluids on demand at controlled temperature regardless of load variations or length of no-load standby. Package includes heat exchanger, trap, strainer, and specially designed temperature regulator featuring single-seated, fully balanced, dead-end steam valve and patented heat-anticipating thermal system. Regulator alone is also available as Model RT-711.

Features: Small overall size; height 43" to 60"; length 44" to 50"; width 10" to 16" depending on model. Single packages 2 to 130 gpm. May be paralleled for greater capacities. Steam valve size: 3/4" to 2". Maximum steam supply: 40 psig. 70°F adjustable setpoint spans between 90°F and 200°F.

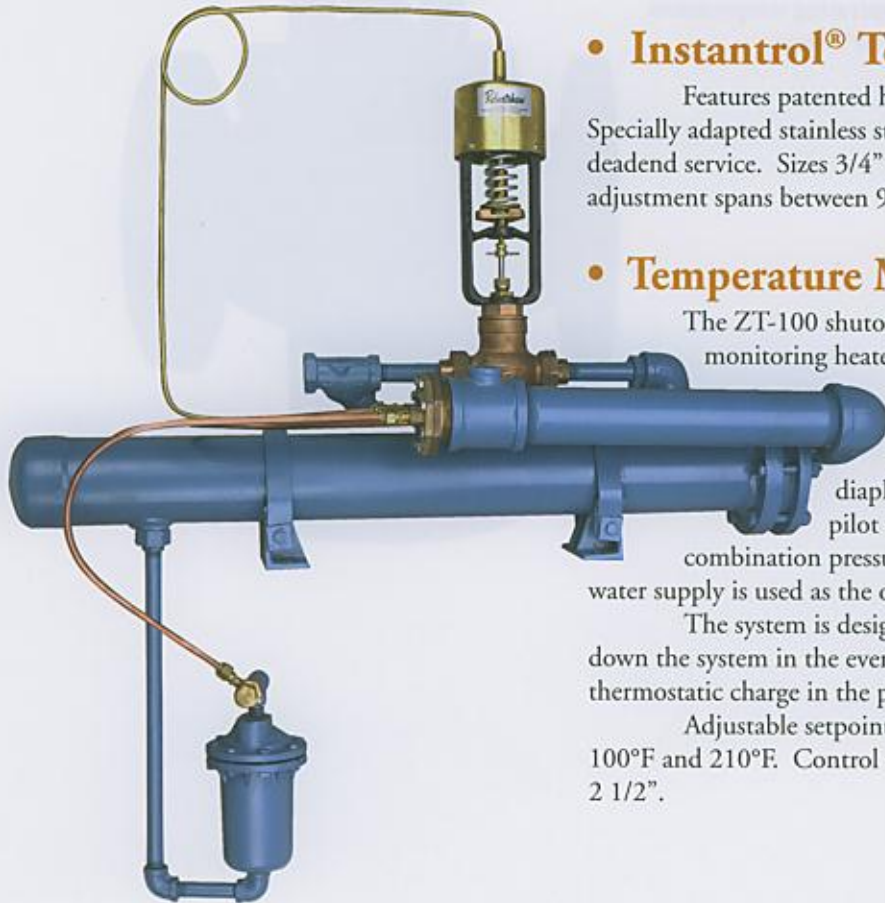

- **Instantrol® Temperature Regulator**

Features patented heat-anticipating, temperature sensing bulb. Specially adapted stainless steel trimmed single-seated valve for deadend service. Sizes 3/4" to 2". Approximately 70°F setpoint adjustment spans between 90°F and 200°F.

- **Temperature Monitoring/Shutdown**

The ZT-100 shutoff system offers an improved means of monitoring heated liquid temperatures and initiating preventive action in the event of a temperature overshoot or damage to the heating system. It includes a single-seated diaphragm control valve, a temperature sensing pilot with a manual relief feature and a combination pressure regulator-strainer-relief valve. Cold water supply is used as the operating medium.

The system is designed to operate in a fail-safe mode, shutting down the system in the event of temperature overruns, loss of thermostatic charge in the pilot valve or loss of cold water supply.

Adjustable setpoint spans are approximately 30°F between 100°F and 210°F. Control valves sizes are 1 1/4", 1 1/2", and 2 1/2".

- **Model 908-A Cooling Water Regulators, Self-Contained**

These compact regulators provide accurate control of cooling water. They are modulating and are easily installed on plastic molds, die casting molds, small condensers, air compressors, etc.

Model 908-A has port sizes 3/8" and 9/16". Process connections 3/4" and 1" for both port sizes. Measures coolant temperature as it flows through valve body. Setpoint infinitely adjustable within ranges of 100-160°F and 140-200°F for 3/8" port and 50-115°F and 100-160°F for 9/16" port.



• Models I-1284 / I-1285 Thermostatic Valves

Models I-1284 / I-1285 thermostatic valves are compact, self-contained and self-powered three-way valves. Designed to control cooling water and lubricating oil temperatures in internal combustion engines. The valves are identical in their thermostatic mode of operation. Model I-1284 contains a manual valve positioning feature which permits manual control of engine temperatures in the event of thermostatic assembly failure.

Valve sizes are 2" to 6" in Class 150 cast bronze bodies; 3" to 6" in Class 150 cast steel bodies. Mid-flow operating temperatures between 60°F to 200°F are available in 10°F steps.



Control Systems Components



• Receiver Indicator Relay - 82059 Series

The 82059 Series is a pneumatic annunciator relay that monitors remote sensors and provides first-out indication and initiates system shutdown or alarm when the sensor setpoint is exceeded. Diaphragm actuators and positive detents ensure consistent reliable operation.

Mounting: Panel

Supply Pressure: 20-50 psig (140-344.7 kPa)

Maximum Pressure: 60 psig (413.67 kPa)

• Temperature Sensors - 85026 Series

The No. 85026 temperature sensor vents to initiate immediate shutdown - safely. It provides reliable protection for either increasing or decreasing temperature applications with quick response due to a metal bellows - actuated, liquid-filled thermostatic element. This rugged and compact device offers predictable linear adjustment. Super-conductive thermowells are optional.

Setpoint Range: 0°F to 400°F

Material: Aluminum or stainless steel

Reset Differential: 6°F to 16°F

Repeatability: ± 5°F

Thermowell Ratings: 5000 psig and 10,000 psig



• Pressure Sensors - 8437x / 8439x Series

These rugged, weatherproof pressure sensors are designed to vent system control pressure and initiate system shutdown - safely (should measured variable setpoint be exceeded). They provide total protection for either increasing or decreasing pressure or differential pressure applications with the added feature of field reversibility. Independent setpoint and reset adjustments are non-interacting. Piped vent connection for gas applications is provided. Pilot operation ensures crisp snap action unaffected by control pressure changes.

Setpoint Range: 7" H₂O to 6500 psig

Control Pressure: 20 psig to 60 psig

Maximum Process Pressure: Up to 9000 psig

Repeatability: ± 1% of setpoint

Materials: Anodized aluminum for general purpose. 316 stainless for offshore environments.

• CR Series Relays

A wide variety of arithmetic functions can be performed with these pneumatic relays. Such functions include addition, subtraction, multiplication, biasing and reversing. They may be used singly, in multiples, or as an integrated system to solve complex process problems. Fully pneumatic, they eliminate any explosion hazard.

Inlet pressure range:

- 0-1.4 bar (0-20 psig) nominal
- 0-3.5 bar (0-50 psig) maximum

Output pressure range:

- 0-1.4 bar (0-20 psig) nominal
- 0-3.5 bar (0-50 psig) maximum

Supply pressure:

- 2.1 bar (30 psig) nominal
- 3.5 bar (50 psig) maximum

Ultimate Sensitivity: 0.1" H₂O

Models Available:

- CR-100-A1 Volume Booster: 1:1 gain (output to input)
- CR-100 Series A/B Ratio Relay: Amplifying ratios 1:2 to 1:6; reducing ratios 6:1 to 2:1.
- CR-101-A1 Volume Booster: with adjustable bias, ratio 1:1
- CR-101 Series A/B Ratio Relay: with adjustable bias, ratios same as CR-100 Series A/B.
- CR-102 Reversing Relay with adjustable bias 1:1 ratio
- CR-103 Averaging Relay 2 inputs through 7 inputs
- CR-104 Summation Relay - Add / Subtract



Logic Relays - 83939 Series

These multi-function, field-selectable logic relays are the basic building blocks for pneumatic logic circuits.

Features:

- Multi-function operation
- Poppet design for non-interflow and large capacity
- Diaphragm actuators for consistent, predictable transfer points
- Anodized aluminum and all 316 stainless steel materials
- Tapped pipe ports permit use of standard industrial tubing fittings



- **Fuel Gas / Starting Air Valve - 85380 Series**

The 85380 Series valve is designed for use either as a fuel gas valve or a starting air valve. Pneumatically actuated, the vent port will close before the main port will open as pressure is applied to the actuator diaphragm. As pressure is removed, the main port will close before the vent port will open.

- Material:** Cast steel bodies with stainless steel trim
- Sizes:** 2" and 3" with Class 150 or Class 300 Flanges
- Vent Size:** 3/4" NPT
- Maximum Diaphragm Pressure:** 50 psig



- **Engine Safety Control - I-530 Series**

The I-530 Series is a dependable, self-contained safety shutdown device which may be used to monitor lube oil pressure, jacket water temperature and overspeed. This safety device will provide a signal to sound an alarm and vent a fuel line as needed. It is field-adjustable. Reset lock lever permits startup bypass for oil pressure function.

- Housing Material:** Cast brass
- Temperature Range:** 135°F to 340°F
- Pressure Range:** 5 to 40 psig (35 kPa to 275 kPa)

- **Temperature-Pressure Switch - I-542 Series**

This rugged, low-cost engine-mounted switch is designed to provide dependable protection against damage from equipment or process. Suitable for applications ranging from safety shutdown in hazardous atmospheres to temperature and pressure monitoring of various processes.

- Rating:** U/L Class I, Group D, hazardous atmosphere
- Temperature Range:** 130°F to 345°F in 20°F spans
- Pressure Range:** 5 to 25 psig (35 kPa to 175 kPa)



Notes:

For use with gas in pressure is applied to the solenoid coil. In pressure is removed, the main port will close before the gas port will open. Materials: Cast steel body with stainless steel wire. Sizes: 1/2" and 3/4" with 1/2" or 3/4" NPT. Pressure Range: 100 to 150 PSI. See page 20 for details.

• Engine Safety Control - I-530 Series

The I-530 series is a high pressure safety control valve. It is designed to shut off the gas supply to the engine in the event of a pressure drop or a high pressure condition. The safety valve will not allow gas to flow until the pressure is restored. It is available in 1/2" and 3/4" sizes with 1/2" or 3/4" NPT. Pressure Range: 100 to 150 PSI. See page 20 for details.



• Temperature-Pressure Switch - I-542 Series

The I-542 series is a high pressure switch that is designed to shut off the gas supply to the engine in the event of a pressure drop or a high pressure condition. It is available in 1/2" and 3/4" sizes with 1/2" or 3/4" NPT. Pressure Range: 100 to 150 PSI. See page 20 for details.





Maryville, Tennessee facility

Robertshaw Industrial Products Division

U.S.A. and Canada

Robertshaw Industrial Products Division
1602 Mustang Drive
Maryville, TN 37801
Phone: 865-981-3096
Fax: 865-981-3168

Exports

Invensys Appliance Controls
1701 Byrd Avenue
P.O. Box 26544
Richmond, Virginia 23261-6544
Phone: 804-756-6500
Fax: 804-756-6561

Call Toll Free 1-800-228-7429
www.robertshawindustrial.com



invensys®